

Coctels Siampaen

Kir Royal 9.50

Palmer & Co Brut Reserve, Crème de Cassis

Coctel Siampaen Clasurol 10.50

Palmer & Co Brut Reserve, Courvosier VSOP Cognac, Angostura bitters, siwgr

Coctels Prosecco

Kir Royal Prosecco 8.50

Prosecco, Crème de Cassis

Bellini 8.50

Prosecco, sudd eirin gwlanog

Aperol Spritz 8.50

Prosecco, Aperol, soda

Coctels heb Alcohol

Môr-forwyn 5.50

Sudd eirin gwlanog, sudd leim, mafon

Angel 5.50

Sudd oren ffres, leim, mwtrin ffrwythau'r dioddefaint

Gardd Fotaneg 5.50

Cordial boldau'r ysgaw, mintys ffres, ciwcymbr, leim, sudd afal

Shirley Temple 5.50

Diod sinsyr, grenadine, sudd leim, ceiriosen Maraschino, tafell oren

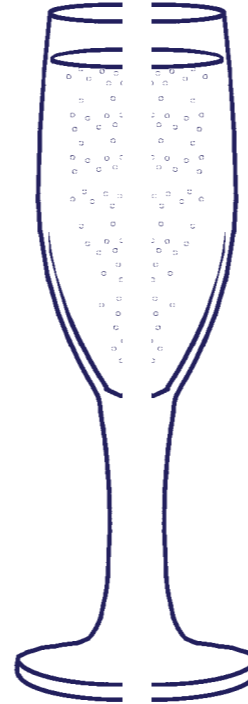

Champagne Cocktails

Kir Royal 9.50

Palmer & Co Brut Reserve, Crème de Cassis

Classic Champagne Cocktail 10.50

Palmer & Co Brut Reserve, Courvosier Vsop Cognac, Angostura bitters, sugar

Prosecco Cocktails

Prosecco Kir Royal 8.50

Prosecco, Crème de Cassis

Bellini 8.50

Prosecco, peach puree

Aperol Spritz 8.50

Prosecco, Aperol, soda

Non Alcoholic Cocktails

Mermaid 5.50

Peach puree, lime juice, raspberries

Angel 5.50

Fresh Orange juice, lime, passionfruit puree

Botanic Garden 5.50

Elderflower cordial, fresh mint, cucumber, lime, apple juice

Shirley Temple 5.50

Ginger ale, grenadine, lime juice, Maraschino cherry, orange slice

Coctels Portmeirion £8.50

Negroni

Jin Aberhonddu/Campari/Cinzano Rosso, tafell o oren

Martini

Jin Aberhonddu/Fodca Aberhonddu, Noilly Prat

Amaretto neu Wisgi Sur

Amaretto neu Wisgi, sudd leim ffres, siwgr surop

Pina Colada

Malibu, hufen cnau coco, sudd pinafal

Mojito

Bacardi, Fodca, sudd leim, siwgr surop, joch o lemonêd, sbrigyn o fintys

Manhattan

Martini Rosso, Whisky, Angostura Bitters

Cosmopolitan

Fodca, Cointreau, sudd leim, sudd llugaeron

Margarita

Tequilla, Grand Marnier, sudd leim, siwgr cansen

Hen Ffasiwn

Jack Daniels, Angostura Bitters

Mai Tai

Rÿm, sudd leim, Cointreau, surop orennau

Mari Waedlyd

Vodka, sudd tomato, saws Caerwrangon, Tabasco, halen môr, lemw'n

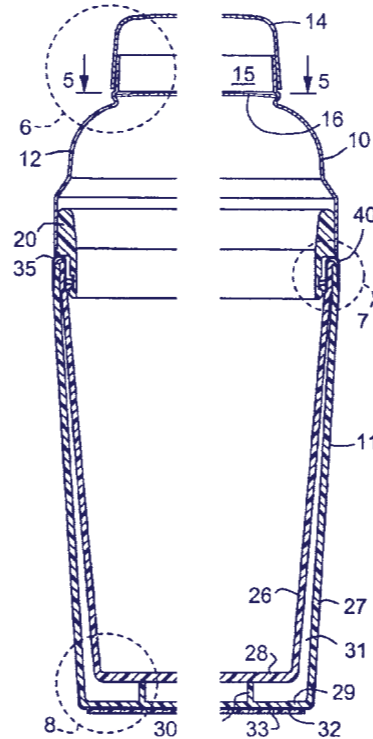

Portmeirion Cocktails £8.50

Negroni

Brecon Gin/Campari/Cinzano Rosso, orange twist

Martini

Brecon Gin/Brecon Vodka, Noilly Prat

Amaretto or Whisky Sour

Amaretto or Whisky, fresh lime juice, sugar syrup

Pina Colada

Malibu, coconut cream, pineapple juice

Mojito

Bacardi, fresh lime, sugar syrup, soda, mint

Manhattan

Martini Rosso, Whisky, Angostura Bitters

Cosmopolitan

Vodka, Cointreau, lime juice, cranberry juice

Margarita

Tequilla, Grand Marnier, fresh Lime, cane sugar

Old Fashioned

Jack Daniels, Angostura Bitters

Mai Tai

Rum, lime juice, Cointreau, Orange syrup

Bloody Mary

Vodka, Tomato Juice, Worcestershire Sauce, Tabasco, sea salt, lemon

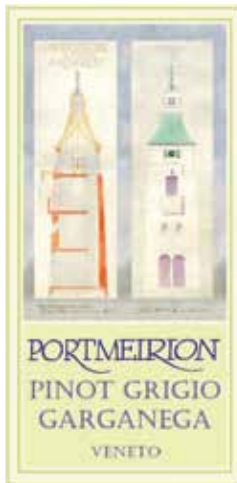

Gwin sych a ffres gydag arlliw o sitrws ac eirin gwlanog, mae'r blas yn gydnerth a dwys.

A fresh dry wine with hints of ripe citrus and white peach, the palate is rich and concentrated.

175ml £5.50
250ml £7.50
750ml £22.00

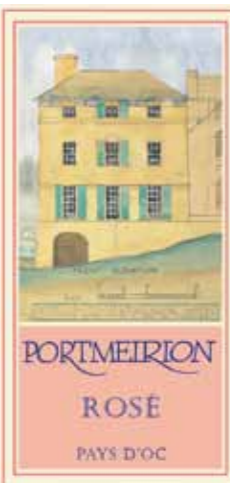

Gwin ffrwythus braf sy'n gyforiog o arogleuon yr haf gyda blasau cynnil o fefus ac eirin duon.

An elegant, lightly fruity rosé with summer fruit aromas of strawberries and plums.

175ml £5.50
250ml £7.50
750ml £22.00

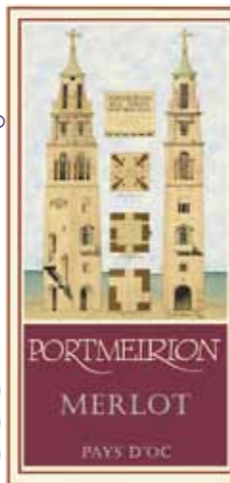

Gwin cydnerth, melfedaidd gydag aroglau mwyar duon a blas ceirios aeddfed ac eirin.

A soft, rich wine with elegant blackberry aromas and typical Merlot plum, cherry and dark fruit notes.

175ml £5.50
250ml £7.50
750ml £22.00

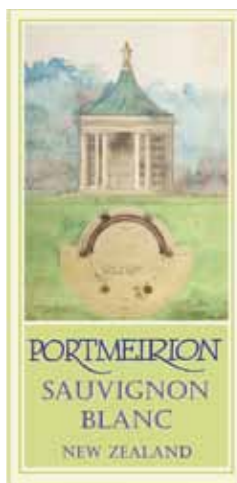

Arogleuon ffrwythau trofannol a leim, gyda blas iachus a ffres ac asidrwydd gloyw.

Passion fruit and lime underpinned by tropical fruit; bright acidity with a crisp finish.

175ml £6.50
250ml £9.00
750ml £26.00

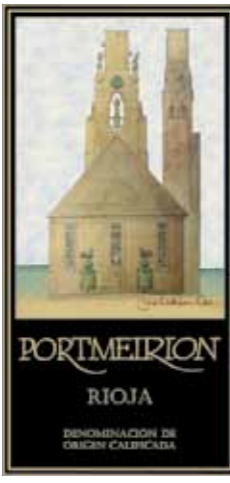

Rioja gloyw rhuddgoch yfadwy, blas aeron cochion aeddfed sbeislyd gydag arlliw o licris.

A bright cherry red colour with red berry & spice flavours & a hint of liquorice in an easy drinking style.

175ml £6.50
250ml £9.00
750ml £26.00

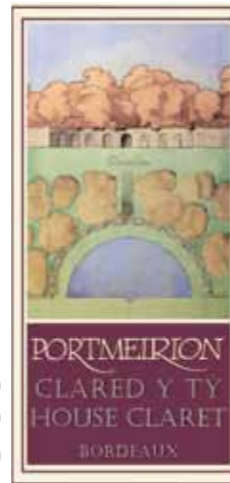

Clasur o glared gyda blas aeron duon aeddfed a thanin ysgafn ar yr ôl-flas.

Classic claret, full bodied and juicy, full of ripe dark berry fruits with soft tannins on the finish.

175ml £6.50
250ml £9.00
750ml £26.00

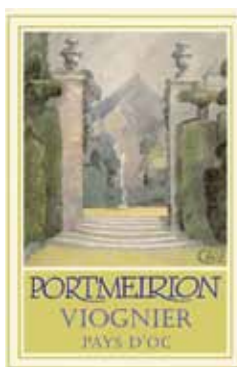

Blas ffres gydag aroglau sitrws, bricyll a ffrwythau gwynion.

Fresh tasting with aromas of citrus, apricot & white fruit.

175ml £5.50
250ml £7.50
750ml £22.00

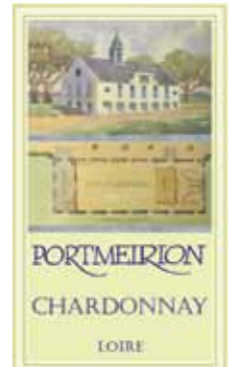

Blas blas eirin gwlanog ac afalau; strwythur cytbwys asidrwydd ffres.

White peach, apple and quince flavours, well balanced with fresh lemony acidity.

175ml £6.50
250ml £9.00
750ml £26.00

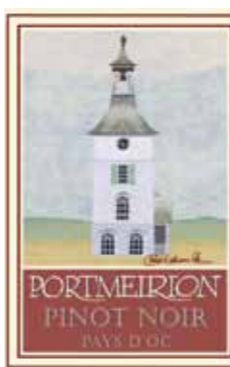

Sidanaidd gydag aroglau ffrwythau cochion a cheirios

Smooth, well balanced Pinot Noir with red fruit aromas & cherry notes

175ml £6.50
250ml £9.00
750ml £26.00

Gwinoedd fesul gwydraid / Wines by the glass



CHAMPAGNE / PROSECCO	125ml	250ml	750ml
Palmer & Co Brut Reserve NV	8.00		46.00
Champagne PORTMEIRION Duval Leroy NV	9.50		56.00
Jeio Prosecco di Valdobbiadene Brut NV	6.50		35.00
GWYN GLOYW A FFRES / CLEAN & CRISP WHITE	175ml	250ml	750ml
PORTMEIRION Dry Hills Sauvignon Blanc, NZ, 2015	6.50	9.00	26.00
Croix des Champs, Sauvignon de Touraine	7.50	9.50	28.00
GWYN FFRES A FFRWYTHUS / FRUITY & AROMATIC WHITE			
Portmeirion Pinot Grigio/Garganega, IGT, Venezia, 2016	5.50	7.50	22.00
Picpoul de Pinet la Côte Flamenc, Languedoc Roussillon, 2016	6.50	9.00	26.00
GWYN MELFEDAIDD A LLYFN / VELVETY & CREAMY WHITE			
Portmeirion Chardonnay, Loire	6.50	9.00	26.00
Petit Chablis, Domaine Manants, Jean-Marc Brocard	9.50	12.00	36.00
GWYN SUDDLON A LLAWN / RICH AND FULL WHITE			
Portmeirion Viognier, IGP, Pays d'Oc, 2016	5.50	7.50	22.00
Côtes du Rhône blanc, Famille Perrin	7.50	9.50	28.00
GWRIDOG / ROSE	175ml	250ml	750ml
Portmeirion Cinsault Rosé, IGP, Pays d'Oc, 2016	5.50	7.50	22.00
Amori Pinot Grigio Blush, Venezia IGT	6.50	9.00	26.00
COCH YSGAFN A FFRWYTHUS / LIGHT AND FRUITY RED	175ml	250ml	750ml
Sangiovese IGT Rubicone, Rometta, Emilia-Romagna	5.50	7.50	22.00
Portmeirion Pinot Noir, IGP, Pays d'Oc, 2016	6.50	9.00	26.00
LLYFN A SUDDLON / SMOOTH & SUCCULENT			
Portmeirion Merlot, IGP, Pays d'Oc, 2016	5.50	7.50	22.00
Portmeirion Rioja, Bodegas del Medievo, Ebro	6.50	9.00	26.00
COETH A THEWYCHEDIG / RICH & CONCENTRATED			
Legato Nero d'Avalo IGT, Sicily	5.50	7.50	22.00
Tarquino Shiraz/Malbec, Argentina	7.50	9.50	28.00
CYDNERTH A SBEISLYD / SPICY AND POWERFUL			
Clared y Ty - Ch.Haut-Gravelier - PORTMEIRION House Claret, 2015	6.50	9.00	26.00
Xanadu Cabernet Sauvignon, Margaret River, Australia	7.50	9.50	28.00

Cynigir y gwinoedd ar fesur 125ml hefyd / Wines by the glass also available in 125ml measures

PRISIAU'R BAR - BAR TARIFF

CWRW CASGEN / DRAUGHT	280ml	560ml
Lager Prahva Lager	2.50	5.00
Cwrw Chwerw IPA Felinfoel Welsh Bitter	2.00	3.90
Lager Wrecsam / Wrexham Lager	2.40	4.60
Seidr Casgen Portmeirion Draught Cider	2.00	3.90

CWRW POTEL / BOTTLED ALES

Sol Lager	3.75
Peroni (Gluten Free)	3.75
Guinness	3.50
Becks Blue (Heb alcohol / Non alcoholic)	3.75
Cwrw Pensaer / Architects Ale	4.80
Cwrw Pentref Portmeirion Village Ale	4.80
Cwrw Cwch Cerrig Portmeirion Stone Boat Ale	4.80
Cwrw Du Rhif 6 Portmeirion No 6 Dark Ale	4.80

SEIDR POTEL / BOTTLED CIDERS

Gwynt y Ddraig Orchard Gold	5.50
Gwynt y Ddraig Perry Vale	5.50
Tomos Watkins Taffy Apple	5.50
Apple County Raspberry	5.50
Apple County Rhubarb	5.50
Apple County Medium sweet	5.50
Apple County Dabinett Medium	5.50

WISGI / WHISKY (25ML)

Wisgi Penderyn Legend Welsh Whisky, 46%	5.00
Wisgi Penderyn Madeira Single Malt 46%	5.50
Wisgi Penderyn Sherrywood Single Malt Dylan Thomas 41%	5.50
Wisgi Penderyn Single Malt Bourbon 41% Bryn Terfel	6.00
Bell's Original Blended Scotch Whisky, 40%	3.50
Glenmorangie 10 year old Single Malt Whisky, 40%	5.00
Talisker 10 year old Island Single Malt Whisky, 45.8%	6.00
Laphroaig 10 year old Isley Single Malt Whisky, 40%	6.00
Glenfiddich Speyside Single Malt Whisky, 40%	4.50
Macallan 15 year Fine Oak Speyside Malt Whisky, 40%	6.00
Dalwhinnie Speyside Single Malt Whisky, 43%	4.50

Jamesons Blended Irish Whiskey, 40%	4.00
Jack Daniel's Tennessee Whiskey, 43%	4.00
Johnny Walker Blue Label Blended Scotch Whisky, 40%	16.00
Ardbeg Uigeadail, 54.2%	6.00
Canadian Club Blended Whisky, 40%	4.50
Highland Park Single Malt, 40%	6.00
Suntory Yamazaki 12 year old Japanese Whisky 40%	7.50

TECILA / TEQUILLA (25ML)

Monte Alban - Mezcal, 40%	4.50
Tequila Olmeca Silver, 38%	3.75
Kah Tequila - Reposado, 55%	6.00

JIN / GIN (25ML)

Jin Aberhonddu / Brecon Special Reserve Welsh Gin, 40%	4.00
Jin Aberhonddu / Brecon Special Botanical Gin 43%	4.00
Bombay Sapphire London Dry Gin, 40%	4.00
Hendrick's Gin, Scotland, 41.4%	4.75
Eccentric Gin Dewi Sant	5.00
Da Mhile Organic Welsh Seaweed Gin, 42%	5.50
Da Mhile Small Batch Welsh Sloe Gin, 25%	5.00
Jinzu Gin (Scottish gin, distilled sake, cherry blossom, yuzu fruit), 41%	6.00
The Botanist Islay Dry Gin, Bruichladdich, 46%	6.00
Forager's Yellow Label Gin, Snowdonia Distillery, 44%	6.00
Forager's Black Label Gin, Snowdonia Distillery, 46%	7.00
Tanqueray No.10 Gin, 47.3%	6.00
Sipsmith London Dry Gin, 41.6%	5.50
Silent Pool, 24 botanicals, 43%	6.00
Pinkster Gin, 37.5%	5.50

FODCA / VODKA (25ML)

Fodca 5 Aberhonddu / Brecon 5 Welsh Vodca, 43%	5.00
Smirnoff Black Label Vodka, 40%	3.75
Ciroc Snap Frost Vodka, distilled from fine French grapes, 40%	5.50
Grey Goose Vodka, France, 40%	6.00
Belvedere Vodka, Poland, 40%	6.00
Sipsmith Sipping Vodka, London 40%	4.75
Zubrowka Bisongrass Vodka, Poland, 40%	4.75
Skorppio Vodka, 37.5%	6.00



RÛM / RUM (25ML)

Rym Sbeislyd Barti Ddu Spiced Rum	5.00
Rebellion Spiced Rum, 37.5%	6.00
Kraken Black Spiced Caribbean Rum, 40%	4.50
Diplomatico Rum Reserva Exclusiva, Venezuela, 40%	6.00
Flor De Cana Centenario 18 Single Estate Nicaraguan Rum, 40%	6.00
Ron Zacapa Centenario Sistema Solera 23 Rum, Guatamala, 40%	7.50
Santa Teresa 1796, Venezuelan Aged Rum, 40%	6.00
R.L. Seale's 10 Year Old Gold Barbados Rum, 46%	6.00
Bacardi Carta Blanca Rum, Santiago de Cuba, 37.5%	3.75

BRANDI / BRANDY (25ML)

Remy Martin VSOP Cognac, 40%	5.50
Courvoisier VSOP Cognac, 40%	5.50
Janneau Bas Armagnac, 40%	6.00
Courvoisier XO Cognac, 40%	9.00
Hennessy XO Cognac, 40%	12.00
Remy Martin XO Excellence Cognac, 40%	12.00

BRANDI AFALAU / APPLE BRANDY (25ML)

Boulard Grand Solage Calvados, Pays d'Auge, 40%	5.50
-------------------------------------------------	------

SHERRY (50ML)

Tio Pepe	4.00
Harveys Amontillado	4.40
Harveys Bristol Cream	4.00
Croft Original	4.00

PORT (50ML)

Grahams Last Bottled Vintage	4.00
Grahams 10 year	5.50
Grahams 20 year	7.50

FERMWTH / VERMOUTH (50ML)

Martini Extra Dry	3.50
Cinzano Bianco	3.50
Cinzano Rosso	3.50
Martini Rosso	3.50
Noilly Prat	3.50
Campari	3.50
Dubonnet	3.50

CYMYSU / MIXERS

Llanllyr Source Tonic	1.80
Llanllyr Source Light Tonic	1.80
Llanllyr Source Ginger Ale	1.80
Llanllyr Source Ginger Beer	1.80
Llanllyr Source Bitter Lemon	1.80

Pepsi	1.80
Diet Pepsi	1.80
Lemonade	1.80
Elderflower, Sparkling	2.00

J20 Orange & Passionfruit	2.95
J20 Apple & Mango	2.95

SUDD FFRWYTHAU / FRUIT JUICE

Sudd Oren / Orange Juice	2.00
Apple Juice	2.00
Cranberry Juice	2.00
Grapefruit Juice	2.00
Pineapple Juice	2.00



